

*Steering Damper Ducati 1199 Panigale,*  
**SD 0401**

Spare Parts List





ADVANCED SUSPENSION TECHNOLOGY

# Safety Precautions

## **Note!**

*The shock absorber is a very important part of the vehicle and will affect the stability.*

 *Read and make sure that you understand the information in this manual and the mounting instructions before you use this product. If you have any questions regarding installation or maintenance please contact an Öhlins dealer.*

 *Öhlins Racing AB can not be held responsible for any damage to the shock absorber, vehicle, other property or injury to persons, if the instructions for installing and maintenance are not followed exactly.*

## **Warning!**

*This product was developed and designed exclusively for a specific vehicle model and should only be installed on the intended vehicle model in its original condition as delivered from the vehicle manufacturer.*

 *This product contains pressurized nitrogen gas (N<sub>2</sub>). Do not open, service or modify this product without proper education (authorized Öhlins dealer/distributor) or proper tools.*

 *After installing this product, take a test ride at low speed to make sure that your vehicle has maintained its stability.*

 *If the suspension makes an abnormal noise, or the function is irregular, or if you notice any leakage from the product, please stop the vehicle immediately and return the product to an Öhlins Service Centre.*

## **Safety Symbols**

In this manual, mounting instructions and other technical documents, important information concerning safety is distinguished by the following symbols:



*The Safety Alert Symbol means: Warning! Your safety is involved.*

### **Warning!**

*The Warning Symbol means: Failure to follow warning instructions can result in severe or fatal injury to anyone working with, inspecting or using the shock absorber, or to bystanders.*

### **Caution!**

*The Caution Symbol means: Special precautions must be taken to avoid damage to the shock absorber.*

### **Note!**

*The Note Symbol indicates information that is important regarding procedures.*

## **Note!**

*When working on this product, always consult your Vehicle Service Manual.*

 *This Manual should be considered a part of the product and should therefore accompany the product throughout its life cycle.*

© Öhlins Racing AB. All rights reserved. Any reprinting or unauthorized use without the written permission of Öhlins Racing AB is prohibited.  
Printed in Sweden.

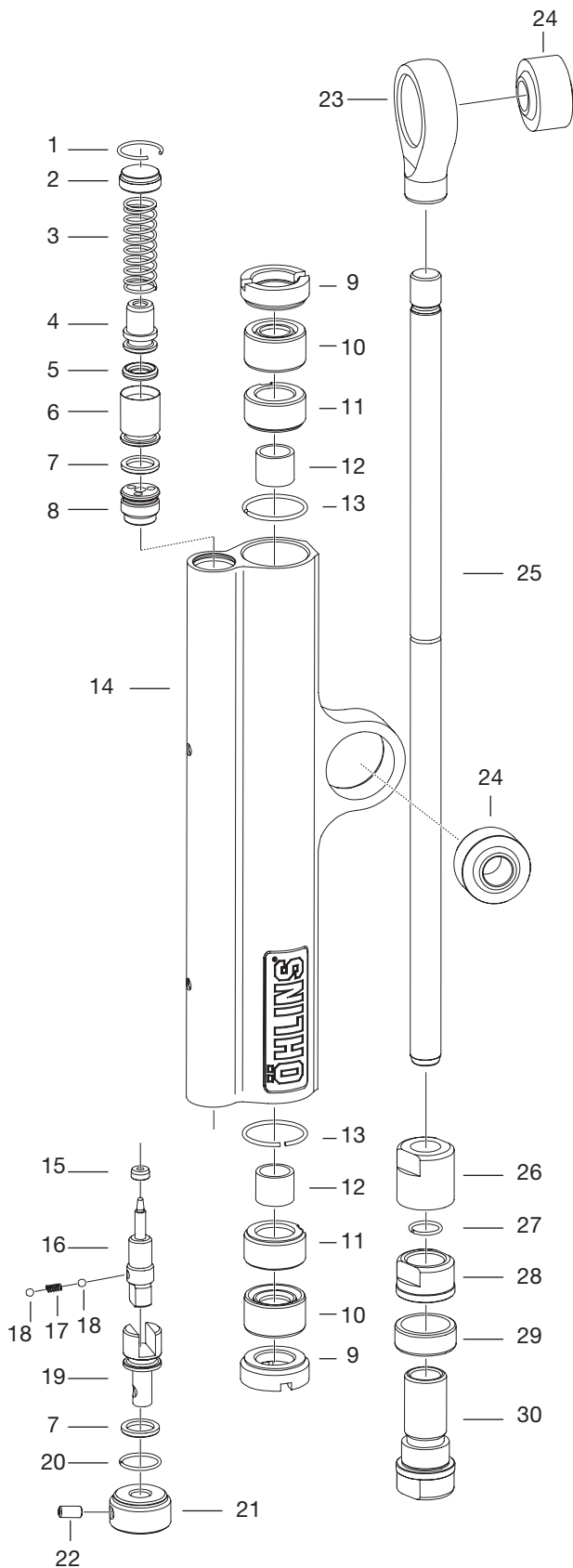

|    | Part No  | Pcs | Description    | Notes |
|----|----------|-----|----------------|-------|
| 1  | 02221-02 | 1   | Circlip        |       |
| 2  | 02212-04 | 1   | Cover          |       |
| 3  | 02215-05 | 1   | Spring         |       |
| 4  | 02276-06 | 1   | Piston inner   |       |
| 5  | 00338-01 | 1   | O-ring         |       |
| 6  | 02276-05 | 1   | Piston outer   |       |
| 7  | 00338-53 | 2   | O-ring         |       |
| 8  | 02227-05 | 1   | Valve assy     |       |
| 9  | 02210-01 | 2   | Cover          |       |
| 10 | 02222-01 | 2   | Seal           |       |
| 11 | 02211-01 | 2   | Bushing holder |       |
| 12 | 01056-09 | 2   | Bushing        |       |
| 13 | 02220-01 | 2   | Circlip        |       |
| 14 | 02263-25 | 1   | Cylinder assy  | 154mm |
| 15 | 02216-01 | 1   | Jet            |       |
| 16 | 02217-01 | 1   | Needle         |       |
| 17 | 01474-01 | 1   | Spring         |       |
| 18 | 00884-04 | 2   | Ball           |       |
| 19 | 02218-01 | 1   | Fork needle    |       |
| 20 | 02221-01 | 1   | Circlip        |       |
| 21 | 02219-02 | 1   | Knob           |       |
| 22 | 01502-02 | 1   | Screw          |       |
| 23 | 02207-08 | 1   | End eye        |       |
| 24 | 02236-07 | 2   | Ball joint     |       |
| 25 | 02256-04 | 1   | Shaft          | 238mm |
| 26 | 02250-01 | 1   | Nut            |       |
| 27 | 02251-01 | 1   | Circlip        |       |
| 28 | 02249-01 | 1   | Sleeve         |       |
| 29 | 02209-01 | 1   | Piston ring    |       |
| 30 | 02248-01 | 1   | Piston         |       |

**See mounting instruction for fitting parts**

Your Öhlins retailer:



Öhlins Racing AB  
Box 722  
SE-194 27, Upplands Väsby  
Sweden

Phone: +46 (0)8 590 025 00  
Fax: +46 (0)8 590 025 80  
[www.ohlins.com](http://www.ohlins.com)



[www.ohlins.com](http://www.ohlins.com)