



Kit Contents	Pcs
Shock absorber	2
Upper spring seat	2
Dust boot	2
Top mount	2
Bearing spacer (L=10 mm)	(2)
Top nut (M12 L=22 mm)	(2)
Spring	2
ABS cable bracket (RH) (GRB/GRF)	1
ABS cable bracket (LH) (GRB/GRF)	1
Nut M8	4
ABS cable bracket (VAF)	2
Used for both front and rear	
C-spanner	1
C-spanner	1
Öhlins sticker	1
Öhlins Owner's Manual	1

👁 Note!

Please note that there can be small differences between your product and the images in these instructions.

👁 Note!

Please note that during storage and transport, especially at high ambient temperature, some of the oil and grease used for assembly may leak and stain the packaging. This will not cause damage to the product, wipe off the excessive oil or grease with a cloth.

👁 Note!

Before you install this product, check the kit contents. If anything is missing, please contact an Öhlins dealer.

⚠ Warning!

Before you install this product, read the Öhlins Owner's manual. This product is an important part of the vehicle and the vehicle stability.

Shock Absorber Kit for Subaru Impreza (GRB/GRF and VAF)

SUS MI10 front

Mounting Instructions



MOUNTING INSTRUCTIONS

⚠ Warning!

It is advisable to have an Öhlins dealer install the shock absorber.

When installing, read your Vehicle Service Manual.

1

Raise the vehicle and put it on jack stands.

⚠ Warning!

Ensure that it is securely supported.

2

Remove the front wheels.

3

Loosen the bolts for the lower strut attachments.

⚠ Caution!

Support the wheel hubs in an appropriate way on each side of the vehicle so that the brake hose and/or drive shaft joint can not be damaged.

4

Loosen the upper attachment. Remove the original struts from the car.

5

Remove the brake hose brackets from the standard struts.

6

Cut the dust boot 20 mm from the lower end with a pair of scissors according to the figure.

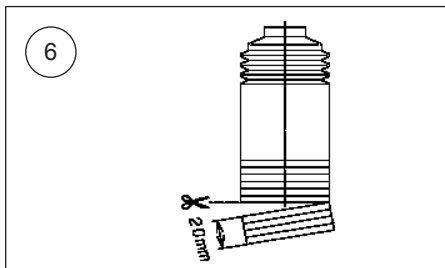

7

Tighten the lower spring seat and the lock nut to 50 - 60 Nm.

Fit the dust boot, the spring and the upper spring seat to the strut according to the figure. Fit the lower bearing spacer, the top mount and the top nut.

Tighten the top nut to 35 - 40 Nm.

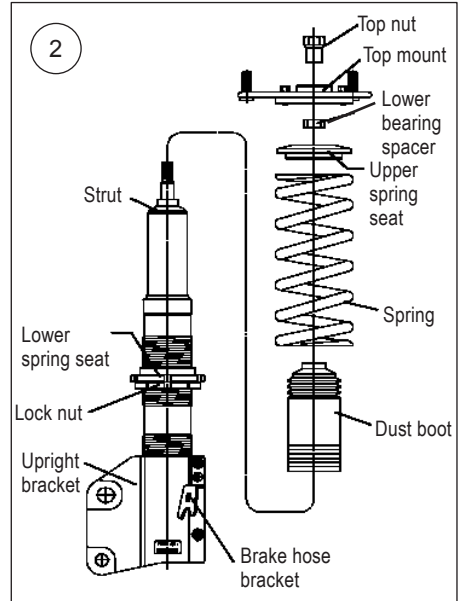

8

Mount the original brake hose to the Öhlins struts. Tighten the nut to 6 Nm.

9

GRB/GAF:

Mount the original ABS cable clamp to the ABS cable bracket according to fig 9A. Tighten the bolt to 6 Nm.

VAF:

Use only the bracket in figure 9B.

👁 Note!

When tightening the top mount nut, the shock absorber shaft must be held in position with a 5 mm Allen key.

MOUNTING INSTRUCTIONS

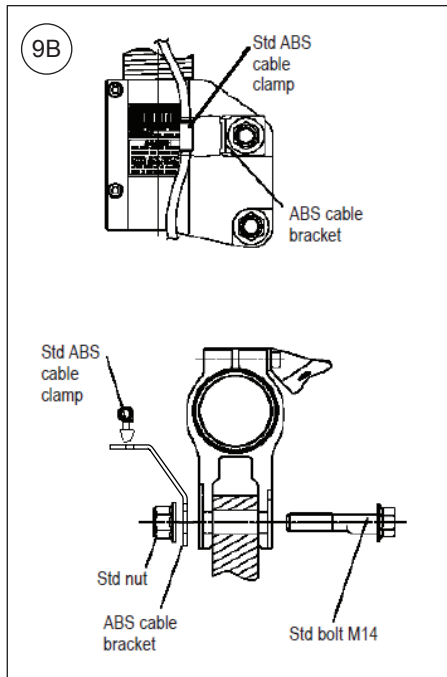
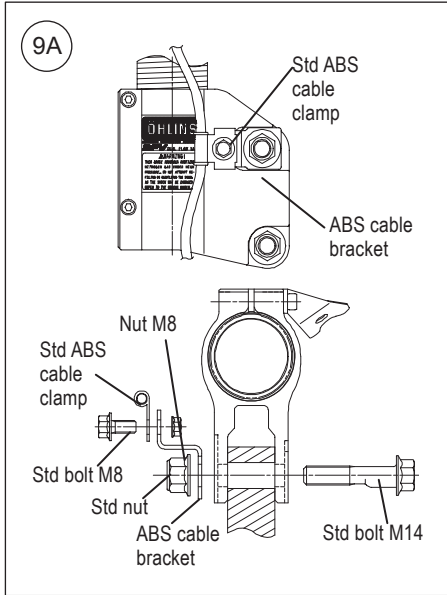

10

Install the Öhlins McPherson struts on the body.

11

Fasten the upper attachments. Set the top mount in position 0, see figure.

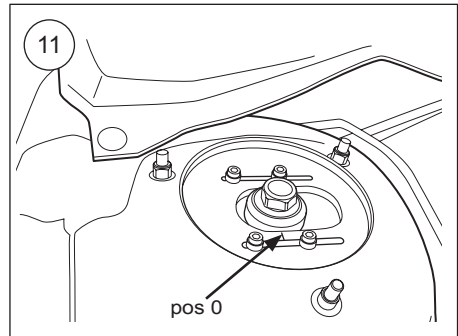

12

Raise the wheel hub with a jack to remove the freeplay of the lower strut attachment bolts before lightening them.

13

Tighten the lower strut attachment bolts after mounting the ABS cable bracket according to fig 9A/9B.

👁 **Note!**

Make sure that all bolts are tightened to the correct torque and that nothing fouls or restricts movement of the strut when it is being fully compressed or extended. Test this over the whole steering range from lock to lock.

14

Make sure that all removed parts are reinstalled in the same way as they were before the installation of the Öhlins shock absorber.

ADJUSTMENTS

⚠ Warning!

Before you ride/drive, always make sure that the setup is according to the recommended setup data. Read about adjustments and setting up in the Öhlins Owner's Manual before you make any adjustments. Contact an Öhlins dealer if you have any questions about setting up.

The standard preload is 2 mm from a free length of 200 mm, giving 198 mm installed length, see fig A.

SETUP DATA

Recommended set-up

Rebound 10 clicks
 Spring preload 2 mm
 GRB/GRF length: 291 mm
 VAF length: 273 mm

Spring

Spec H200, ID65, 90N/mm

The actual vehicle height

With both the preload and height adjustments in their standard positions, the vehicle is lowered approximately 20 mm for the GRB/GRF models and 25 mm for the VAF model when compared to the original suspension. As the height adjuster is turned one rotation, the position moves 2.0 mm.

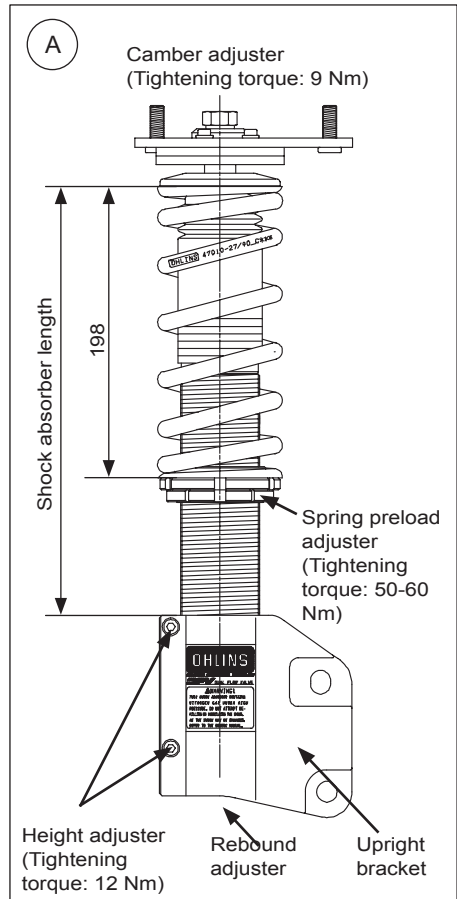

⚠ Warning!

The adjustment range is the standard position -10 to +15 mm. If the bracket is moved outside the adjustment range, it may come loose.

Öhlins products are subject to continuous improvement and development, therefore, although these instructions include the most up-to-date information available at the time of printing, minor updates may occur.

To find the latest information contact an Öhlins distributor. Please contact Öhlins if you have any questions regarding the contents in this document.

Part no. MI_SUSM10_front_3
 Issued 2015-03-12

© Öhlins Racing AB. All rights reserved. Any reprinting or unauthorized use without the written permission of Öhlins Racing AB is prohibited.

Öhlins Racing AB
 Box 722
 S-194 27 Upplands Väsby, Sweden
 Phone +46 8 590 025 00
 fax +46 8 590 025 80



www.ohlins.com



Kit Contents	Pcs
Shock absorber	2
Dust boot	2
Top mount	2
Spring	2
Bushing spacer	4
Self lock nut M12	2
Mounted on shock absorber	
Adjuster	2
Used for both front and rear	
C-spanner	1
C-spanner	1
Öhlins sticker	1
Öhlins Owner's Manual	1

👁 Note!

Please note that there can be small differences between your product and the images in these instructions.

👁 Note!

Please note that during storage and transport, especially at high ambient temperature, some of the oil and grease used for assembly may leak and stain the packaging. This will not cause damage to the product, wipe off the excessive oil or grease with a cloth.

👁 Note!

Before you install this product, check the kit contents. If anything is missing, please contact an Öhlins dealer.

⚠ Warning!

Before you install this product, read the Öhlins Owner's manual. This product is an important part of the vehicle and the vehicle stability.

Shock Absorber Kit for Subaru Impreza (GRB/GRF and VAF)

SUS MI10 rear

Mounting Instructions



MOUNTING INSTRUCTIONS

⚠ Warning!

It is advisable to have an Öhlins dealer install the shock absorber.

When installing, read your Vehicle Service Manual.

1

Raise the vehicle and put it on jack stands.

⚠ Warning!

Ensure that it is securely supported.

2

Remove the rear wheels.

3

Remove the lower and the upper attachments and remove the original shock absorbers.

4

Cut the dust boot 52 mm from the lower end with a pair of scissors according to the figure.

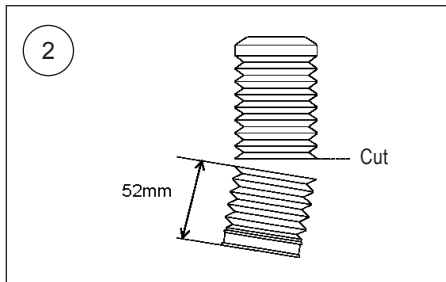

5

Tighten the lower spring seat and the lock nut to 50 - 60 Nm.

Fit the bushing spacers, the dust boot, the spring, the top mount and the adjuster according to the figure. Tighten the self nut to 30 Nm.

👁 Note!

When tightening the top mount nut, the shock absorber shaft must be held in position with a flat screwdriver.

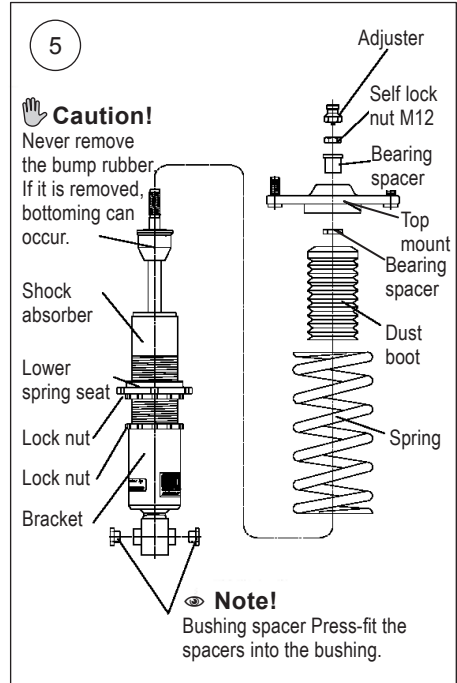

MOUNTING INSTRUCTIONS

6

Install the Öhlins shock absorbers on the vehicle.

7

Fasten the upper attachments.

👁 **Note!**

Make sure that all bolts are tightened to the correct torque and that nothing fouls or restricts movement of the shock absorber when it is being fully compressed or extended.

8

Make sure that all removed parts are reinstalled in the same way as they were before the installation of the Öhlins shock absorber.

3a

Applicable for the GRB/GRF model:
Left side of vehicle body inside trunk room

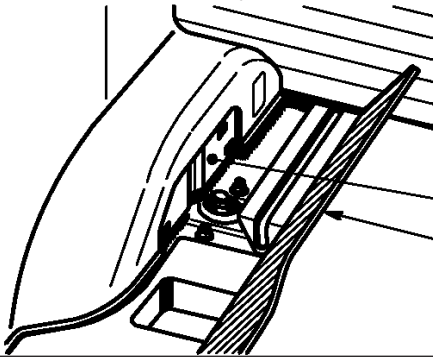

Remove the side panel, because the panel touches the adjuster.

Adjuster is under the cover.

3b

Applicable for the VAF model:



First lift the floor carpet in the trunk.



The adjuster is located under the flap (shown on the left side), when you have lift the carpet in the trunk.



Lift the small side flap to access the adjuster.

ADJUSTMENTS

⚠ Warning!

Before you ride/drive, always make sure that the setup is according to the recommended setup data. Read about adjustments and setting up in the Öhlins Owner's Manual before you make any adjustments. Contact an Öhlins dealer if you have any questions about setting up.

The standard preload is 2 mm from a free length of 200 mm, giving 198 mm installed length, see fig 4.

SETUP DATA

Recommended set-up

Rebound 10 clicks
Spring preload 2 mm
GRB/GRF length: 392 mm
VAF length: 383 mm

Spring

Spec H200, ID65, 70N/mm

The actual vehicle height

With both the preload and height adjustments in their standard positions, the vehicle is lowered approximately 20 mm for the GRB/GRF models and 15 mm for the VAF model when compared to the original suspension. As the height adjuster is turned one rotation, the position moves 2.0 mm.

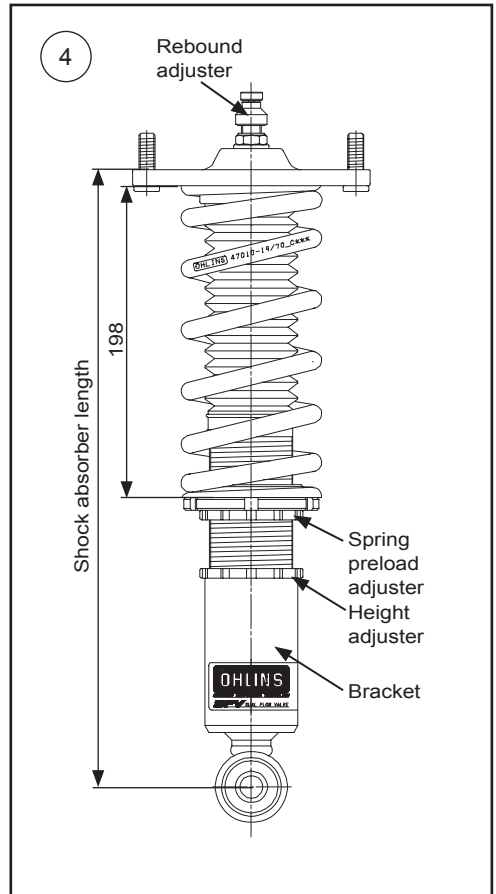

⚠ Warning!

The adjustment range is the standard position ± 15 mm. If the bracket is moved outside the adjustment range, it may come loose.

Öhlins products are subject to continuous improvement and development, therefore, although these instructions include the most up-to-date information available at the time of printing, minor updates may occur.

To find the latest information contact an Öhlins distributor. Please contact Öhlins if you have any questions regarding the contents in this document.

Part no. MI_SUSM10_rear_3
Issued 2015-03-12

© Öhlins Racing AB. All rights reserved. Any reprinting or unauthorized use without the written permission of Öhlins Racing AB is prohibited.

Öhlins Racing AB
Box 722
S-194 27 Upplands Väsby, Sweden
Phone +46 8 590 025 00
fax +46 8 590 025 80



www.ohlins.com