

Note!

Please note that there can be small differences between your product and the images in these instructions.

Note!

Please note that during storage and transport, especially at high ambient temperature, some of the oil and grease used for assembly may leak and stain the packaging. This will not cause damage to the product, wipe off the excessive oil or grease with a cloth.

Kit Contents

Description	Part No	Pcs
Front fork	FGRT214	1
Screw M66S M5x10	01046-38	4
Sticker set Öhlins		1
Owner's manual	07282-07	1
Fender bracket, front	21665-03	2

Threadlocker

Threadlocker medium, Loctite 243	01791-03
----------------------------------	----------

Note!

Before you install this product, check the kit contents. If anything is missing, please contact an Öhlins dealer.

Warning!

Before you install this product, read the Öhlins Owner's manual. This product is an important part of the vehicle and the vehicle stability.

Front fork for Ducati 899 Panigale, Ducati 959 Panigale and Ducati Panigale V4.

FGRT 214

Mounting Instructions



MOUNTING INSTRUCTIONS

⚠ Warning!

We strongly recommend to let an Öhlins dealer install this product.

⚠ Warning!

If you work with a lifted vehicle, make sure that it is safely supported to prevent it from tipping over.

👁 Note!

When you work with this product, see the vehicle service manual for vehicle specific procedures and important data.

👁 Note!

Before you install this product clean the vehicle.

1

Put the motorcycle on a work stand so that the rear wheel barely touches the ground.

2

Remove the front fender, brake caliper, ABS-sensor (if any), and the front wheel.

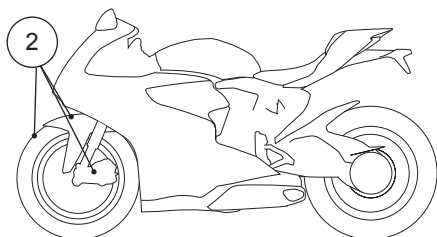

3

Loosen the upper and lower triple clamps by loosening the screws.

4

Remove the fork legs from the triple clamps.

5

Install the supplied fender brackets to the fork legs according to the figure.
Apply threadlocker (01791-03) or similar on the screws and tighten to 4 Nm.

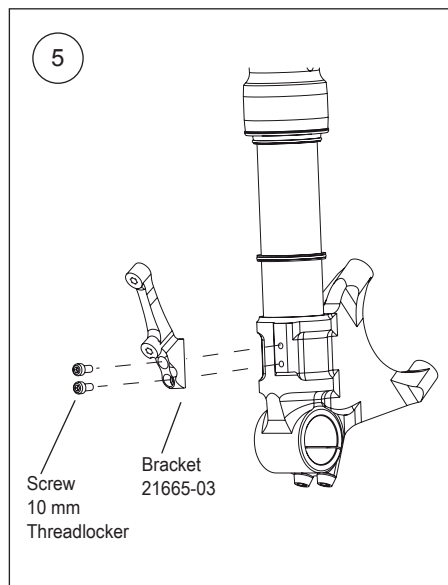

MOUNTING INSTRUCTIONS

6

Install the fork legs into the triple clamps to the recommended fork leg position in the setup data. Position the fork legs so that the outer machining is in a 90° angle from the vehicle direction.

Tighten the triple clamps:
Upper triple clamp 20 Nm
Lower triple clamp 10 Nm

Turn the handle bars fully from side to side to make sure that nothing restricts the movement, and that the throttle cable and wire harness run with soft bends.

Caution!

The surface of the outer machining must be in a 90° angle from the vehicle direction.

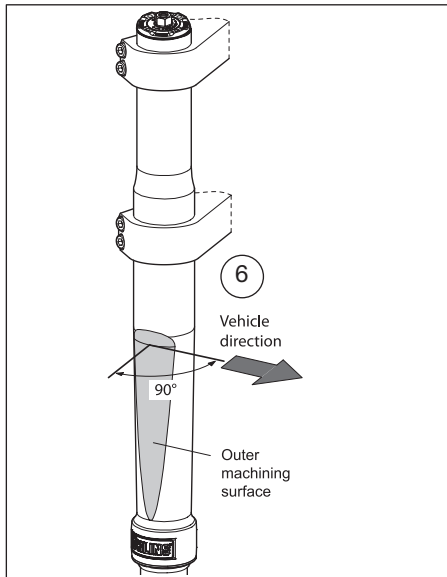

7

Vehicle equipped with ABS; Install the ABS-sensor.

8

Install the front fender, front wheel, and the brake calipers.
Do not tighten yet.

9

Put the vehicle on the ground, apply the front brake and compress the front fork distinctly 3-4 times. This will put the legs in an exact parallel position.

10

Tighten the front wheel, brake calipers, and the front fender.

See the vehicle service manual for correct tightening torques.

11

Make sure that nothing restricts the fork movement when fully compressed.

Note!

In storage or transport the oil in the front fork can be displaced and therefore temporarily loses some of its damping performance.

12

Close the rebound and compression adjusters.

13

Compress the front fork as much as possible several times to bleed out the air. Make sure that there is damping on the full stroke.

14

See the setup data to see the recommended setup for the rebound and compression adjusters.

15

Read more in the Öhlins Owner's manual - Chapter Setting up your front fork, Extended stroke.

Note!

Lower the vehicle so that the suspension is slightly compressed before you tighten the screws.

Caution!

Make sure that you tighten all screws to the correct torque and that nothing fouls or restricts movement of the shock absorber/front fork/steering damper when the suspension is fully compressed or extended.

ADJUSTMENTS

⚠ Warning!

Before you ride/drive, always make sure that the setup is according to the recommended setup data. Read about adjustments and setting up in the Öhlins Owner's Manual before you make any adjustments. Contact an Öhlins dealer if you have any questions about setting up.

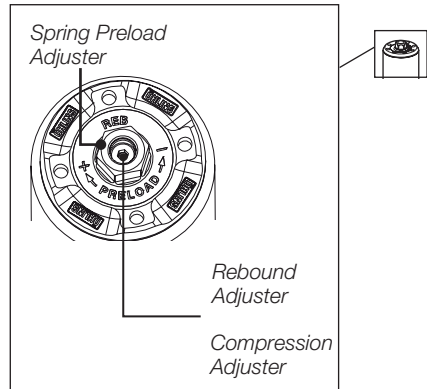

SETUP DATA

Compression	12	clicks
Rebound	12	clicks
Spring preload	6	mm
Oil level	150	mm
Fork leg position	4.5	mm
Spring		
Standard spring, part no.	04744-10	
Spring rate	10	N/mm

Öhlins products are subject to continuous improvement and development, therefore, although these instructions include the most up-to-date information available at the time of printing, minor updates may occur.

To find the latest information contact an Öhlins distributor. Please contact Öhlins if you have any questions regarding the contents in this document.

Part no. MI_FGRT214_1
Issued 2017-01-01

© Öhlins Racing AB. All rights reserved. Any reprinting or unauthorized use without the written permission of Öhlins Racing AB is prohibited.

Öhlins Racing AB
Box 722
S-194 27 Upplands Väsby, Sweden
Phone +46 8 590 025 00
fax +46 8 590 025 80



www.ohlins.com